

Rohr NW 100, Flansche nach DIN 2631 NW 100
pipe size NW 100, flanges according DIN 2631 NW 100

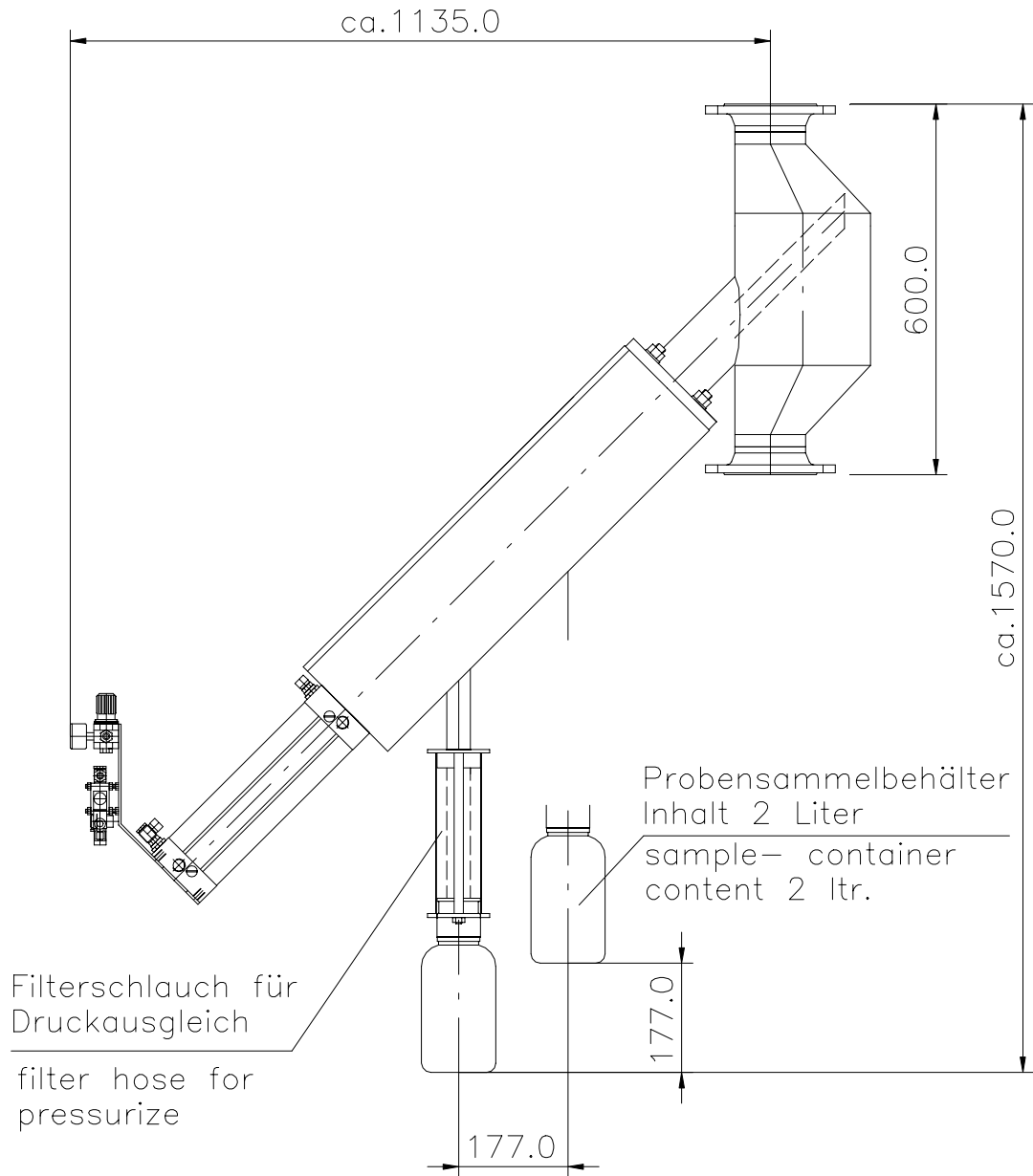

 ARTUR RODDAY
PROBENAHMETECHNIK

Benennung
designation

Rohrprobenehmer Typ RP45 Hub 250
sample extractor type RP45 stroke 250